

**Characteristics:**

**General Description:**

The single and dual channel Temperature Signal Converter D5072S and D5072D accepts a low level dc signal from millivolt, thermocouple or 2-3-4 wire resistance/RTD or transmitting potentiometer sensor, located in Hazardous Area, and converts, with isolation, the signal to drive a Safe Area load, suitable for applications requiring SIL 2 level (according to IEC 61511) in safety related systems for high risk industries. Output signal can be direct or reverse.

Modbus RTU RS-485 output is available on Bus connector.

Cold junction compensation can be programmed as:

- Automatic: provided by an internal temperature sensor;
- Fixed: to a user-customizable temperature value;
- Remote: (only D5072D) connecting compensation RTD to one of the two ch.

For D5072D module: duplicator function provides two independent outputs from one single input.

Output function can be configured as: Adder, subtractor, low/high selector.

Modules are provided with alarm function, which is available via photoMOS output, Termination Board and Power Bus.

Mounting on standard DIN-Rail, with or without Power Bus, or on customized Termination Boards, in Safe Area / Non Hazardous Location or in Zone 2 / Class I, Division 2 or Class I, Zone 2.

**Fault Detection:**

D5072S and D5072D modules are able to detect multiple fault sources:

- Sensor Burnout (i.e. when input is disconnected);
- Sensor out of configured range;
- Analog output saturation (beyond user-configured output limits);
- Internal module fault;
- Module out of allowed temperature range (-40 to +70 °C).

Modules can be programmed to reflect fault status on Analog or Alarm Output.

All data is available also via Modbus Output.

**Front Panel and Features:**

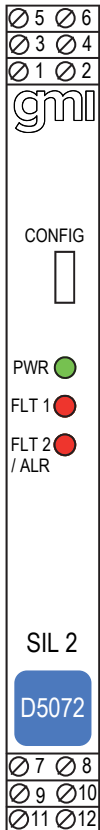

- D5072 SIL 2 according to IEC61511 for Tproof=3/10yrs (≤10% / >10 % of total SIF), SFF 79.88% PFDavg (1 year) 3.16 E-04, with analog current output.
- Input from Zone 0 (Zone 20) / Division 1, installation in Zone 2 / Division 2.
- mV, thermocouple, 2 or 3 or 4 wire resistance/RTD or transmitting potentiometer Input Signal.
- 2-wire RTD line resistance compensation.
- Internal Reference Junction Compensation automatic or fixed (programmable value).
- Fastest integration time: 50 ms
- Fully customizable Output range from 0 to 24 mA Output Signal linear or reverse (typical 0/4-20 mA).
- Output duplication possible for D5072D.
- Modbus RTU RS-485 Output.
- Independent multiple Fault detection.
- Programmable alarm available on photoMOS output or Termination Board connector.
- High Accuracy, µP controlled A/D converter.
- Three port isolation, Input/Output/Supply.
- EMC Compatibility to EN61000-6-2, EN61000-6-4, EN61326-1, EN61326-3-1 for safety system.
- Fully programmable operating parameters.
- ATEX, IECEx, FM, FMC, INMETRO, EAC-EX, UKR TR n. 898, NEPSI, TIIS, TUV Certifications.
- Type Approval Certificate DNV and KR for maritime applications.
- High Density, two channels per unit.
- Simplified installation using standard DIN-Rail and plug-in terminal blocks, with or without Power Bus, or customized Termination Boards.
- 250 Vrms (Um) max. voltage allowed to the instruments associated with the barrier.
- Data logging and monitoring via software.

**Ordering Information:**

Model:	D5072	Power Bus and DIN-Rail accessories: Connector JDFT049
1 channel	S	Cover and fix MCHP196
2 channels	D	Terminal block male MOR017
		Terminal block female MOR022

Operating parameters are programmable from PC by the GM Pocket Portable Adapter PPC5092 via USB serial line and SWC5090 Configurator software.

**Technical Data:**

**Supply:** 24 Vdc nom (18 to 30 Vdc) reverse polarity protected, ripple within voltage limits ≤ 5 Vpp, 2 A time lag fuse internally protected.

**Current consumption @ 24 V:** 55 mA (D5072D), 45 mA (D5072S) with 20 mA out typical.

**Power dissipation:** 1.15 W for 2 channels D5072D, 1.0 W for 1 channel D5072S with 24 V supply voltage and 20 mA output typical.

**Isolation (Test Voltage):** I.S. In/Out 2.5 KV; I.S. In/Supply 2.5 KV; I.S. In/I.S. In 500 V; Out/Supply 500 V; Out/Out 500 V.

**Input:** millivolt or thermocouple type A1, A2, A3, B, E, J, K, L, LR, N, R, S, T, U, or 2-3-4 wire RTD Pt50, Pt100, Pt200, Pt300, Pt400, Pt500, Pt1000 (IEC), Pt100 (ANSI 0.3916), Ni100, Ni120 (DIN43760), Pt46, Pt50, Pt100, Pt200, Pt300, Pt400, Pt500, Cu50, Cu53, Cu100 (GOST6651 russian standard) and Cu9.035 (or Cu10), or 3 wire transmitting potentiometer (100 Ω to 10 kΩ). 4-wire RTD input only on D5072S. Possibility of configuring user customized sensor (TC or RTD). Choice between °C/°F. See section "Input specifications" for more details on Input sensors.

**Integration time:** from 50 ms to 500 ms depending on sensor and fast/slow integration.

**Resolution:** 1 µV on mV/TC, 1 mΩ on RTD/resistance, 0.0001 % on transmitting pot.

**Visualization:** 0.1 °C on temp., 10 µV on mV, 100 mΩ on resistance, 0.1 % on pot.

**Input range:** within sensor limits (-50 to +80 mV for TC/mV, 0-4 kΩ for resistance).

**Measuring RTD current:** ≤ 0.15 mA.

**2 wire RTD line resistance compensation:** ≤ 100 Ω (programmable).

**Thermocouple Reference Junction Compensation:** programmable as automatic with internal compensator, fixed (-60 to +100 °C), or remote using 1 channel (D5072D).

**Thermocouple burnout current:** ≤ 50 µA.

**Fault:** enabled or disabled. Analog output can be programmed to reflect fault conditions via downscale, highscale or customized value forcing. Fault conditions are also signaled via BUS and by red LED on front panel for each channel. Fault conditions are: Sensor burnout, Sensor out of range, Output saturation, Internal fault, Module out of temperature range.

**Output:** Fully customizable 0/4 to 20 mA, on max. 300 Ω load source mode, current limited at 24 mA. In sink mode, external voltage generator range is V min. 3.5V at 0Ω load and V max. 30V. If generator voltage Vg > 10 V, a series resistance ≥ (Vg - 10)/0.024 Ω is needed. The maximum value of series resistance is (Vg - 3.5)/0.024 Ω.

**Resolution:** 1 µA current output.

**Transfer characteristic:** linear, direct or reverse on all input sensors.

**Response time:** ≤ 20 ms (10 to 90 % step).

**Output ripple:** ≤ 20 mVrms on 250 Ω load.

**Modbus Output:** Modbus RTU protocol up to 115.200 baud on Bus connector.

**Alarm: Trip point range:** within rated limits of input sensor (see input step resolution).

**ON-OFF delay time:** 0 to 1000 s, 100 ms step.

**Hysteresis:** 0 to 500 °C for TC/RTD sensor input, 0 to 50 mV for mV input, 0 to 50 % for potentiometer input, 0 to 2 kΩ for resistance (see input for step resolution).

**Output:** voltage free SPST photoMOS: 100 mA, 60 Vdc (≤ 1 V voltage drop).

**Performance:** Ref. Conditions 24 V supply, 250 Ω load, 23 ± 1 °C ambient temperature, slow integration mode, 4-wires configuration for RTD.

**Input: Calibration and linearity accuracy:** see section "Input Specifications".

**Temperature influence:** ≤ ± 2 µV on mV or thermocouple, ± 20 mΩ on RTD (≤ 300 Ω @ 0°C) or ± 200 mΩ on RTD (> 300 Ω @ 0°C), ± 0.02 % on potentiometer for a 1 °C change.

**Ref. Junction Compensation influence:** ≤ ± 1 °C (thermocouple sensor).

**Analog Output: Calibration accuracy:** ≤ ± 0.05 % of full scale.

**Linearity error:** ≤ ± 0.05 % of full scale.

**Supply voltage influence:** ≤ ± 0.02 % of full scale for a min to max supply change.

**Load influence:** ≤ ± 0.02 % of full scale for a 0 to 100 % load resistance change.

**Temperature influence:** ≤ ± 0.01 % on zero and span for a 1 °C change.

**Compatibility:** CE mark compliant, conforms to Directive: 2014/34/EU ATEX, 2014/30/EU EMC, 2014/35/EU LVD, 2011/65/EU RoHS.

**Environmental conditions:** Operating: temperature limits -40 to +70 °C, relative humidity 95 %, up to 55 °C. Storage: temperature limits -45 to +80 °C.

**Safety Description:**

**ATEX:** II 3(1)G Ex nA [ja Ga] IIC T4 Gc, II (1)D [Ex ia Da] IIIC, I (M1) [Ex ia Ma] I

**IECEx / INMETRO / NEPSI:** Ex nA [ja Ga] IIC T4 Gc, [Ex ia Da] IIIC, [Ex ia Ma] I

**FM:** NI-AIS / I / 2 / ABCD / T4, AIS / I.II.III / 1 / ABCDEFG, I / 2 / Ex nA [ja] / IIC / T4

**FMC:** NI-AIS / I / 2 / ABCD / T4, AIS / I.II.III / 1 / ABCDEFG, I / 2 / Ex nA [ja] / IIC / T4

**EAC-EX:** 2Ex nA [ja Ga] IIC T4 Gc X, [Ex ia Da] IIIC, [Ex ia Ma] I

**UKR TR n. 898:** 2ExnAiaIIC T4 X, ExIal X associated apparatus and non-sparking electrical equipment.

D5072S: Uo/Voc = 7.2 V, Io/Isc = 23 mA, Po/Po = 40 mW, Uil/Vmax = 12.8 V, Iil/Imax = 28.7 mA, Ci = 0 nF, Li = 0 nH at terminals 7-8-9-10.

D5072D: Uo/Voc = 7.2 V, Io/Isc = 16 mA, Po/Po = 27 mW, Uil/Vmax = 12.8 V, Ci = 0 nF, Li = 0 nH at terminals 7-8-9, 10-11-12. Um = 250 Vrms, -40 °C ≤ Ta ≤ 70 °C.

**Approvals:** BVS 12 ATEX E 053 X conforms to EN60079-0, EN60079-11, EN60079-15, IECEx BVS 12.0050X conforms to IEC60079-0, IEC60079-11, IEC60079-15, INMETRO DNV 13.0110 X conforms to ABNT NBR IEC60079-0, ABNT NBR IEC60079-11, ABNT NBR IEC60079-15, ABNT NBR IEC60079-26, FM 3046304 and FMC 3046304C conforms to Class 3600, 3610, 3611, 3810, ANSI/ISA-60079-0, ANSI/ISA-60079-11, ANSI/ISA-60079-15, C22.2 No.142, C22.2 No.157, C22.2 No.213, C22.2 No. 60079-0, C22.2 No. 60079-11, C22.2 No. 60079-15, C-IT.MH62.B.04182 conforms to GOST R IEC 60079-0, GOST R IEC 60079-11, GOST R IEC 60079-15, CLJ 16.0036 X conforms to ДСТУ 7113, ГОСТ 22782-5-78, ДСТУ IEC 60079-15, GYJ14.1406X conforms to GB3836.1, GB3836.4, GB3836.8, GB3836.20, TC21131 for TIIS approval (only for D5072D).

TUV Certificate No. C-IS-236198-02, SIL 2 according to IEC 61511. DNV Type Approval Certificate No.A-13625 and KR No.MIL20769-EL002 Certificates for maritime applications.

**Mounting:** T35 DIN-Rail according to EN50022, with or without Power Bus or on customized Termination Board.

**Weight:** about 135 g D5072D, 130 g D5072S.

**Connection:** by polarized plug-in disconnect screw terminal blocks to accommodate terminations up to 2.5 mm<sup>2</sup>.

**Location:** installation in Safe Area/Non Hazardous Locations or Zone 2, Group IIC T4 or Class I, Division 2, Group A,B,C,D, T4 or Class I, Zone 2, Group IIC, T4.

**Protection class:** IP 20.

**Dimensions:** Width 12.5 mm, Depth 123 mm, Height 120 mm.

**Parameters Table:**

Safety Description	Maximum External Parameters			
	Group Cenelec	Co/Ca (μF)	Lo/La (mH)	Lo/Ro (μH/Ω)
<b>D5072S:</b> Terminals 7-8-9-10 Uo/Voc = 7.2 V Io/Isc = 23 mA Po/Po = 40 mW Ui/Vmax = 12.8 V Ii/Imax = 28.7 mA Ci = 0 nF, Li = 0 nH	IIC	13.5	67	875
	IIB	240	268	3500
	IIA	1000	537	7000
	I	1000	882	11480
	IIIC	240	268	3500
<b>D5072D:</b> Terminals 7-8-9,10-11-12 Uo/Voc = 7.2 V Io/Isc = 16 mA Po/Po = 27 mW Ui/Vmax = 12.8 V Ci = 0 nF, Li = 0 nH	IIC	13.5	138	1290
	IIB	240	555	5160
	IIA	1000	1111	10330
	I	1000	1822	16950
	IIIC	240	555	5160

**Image:**



**Function Diagram:**

HAZARDOUS AREA ZONE 0 (ZONE 20) GROUP IIC,  
HAZARDOUS LOCATIONS CLASS I, DIVISION 1, GROUPS A, B, C, D,  
CLASS II, DIVISION 1, GROUPS E, F, G, CLASS III, DIVISION 1,  
CLASS I, ZONE 0, GROUP IIC

SAFE AREA, ZONE 2 GROUP IIC T4,  
NON HAZARDOUS LOCATIONS, CLASS I, DIVISION 2,  
GROUPS A, B, C, D T-Code T4, CLASS I, ZONE 2, GROUP IIC T4

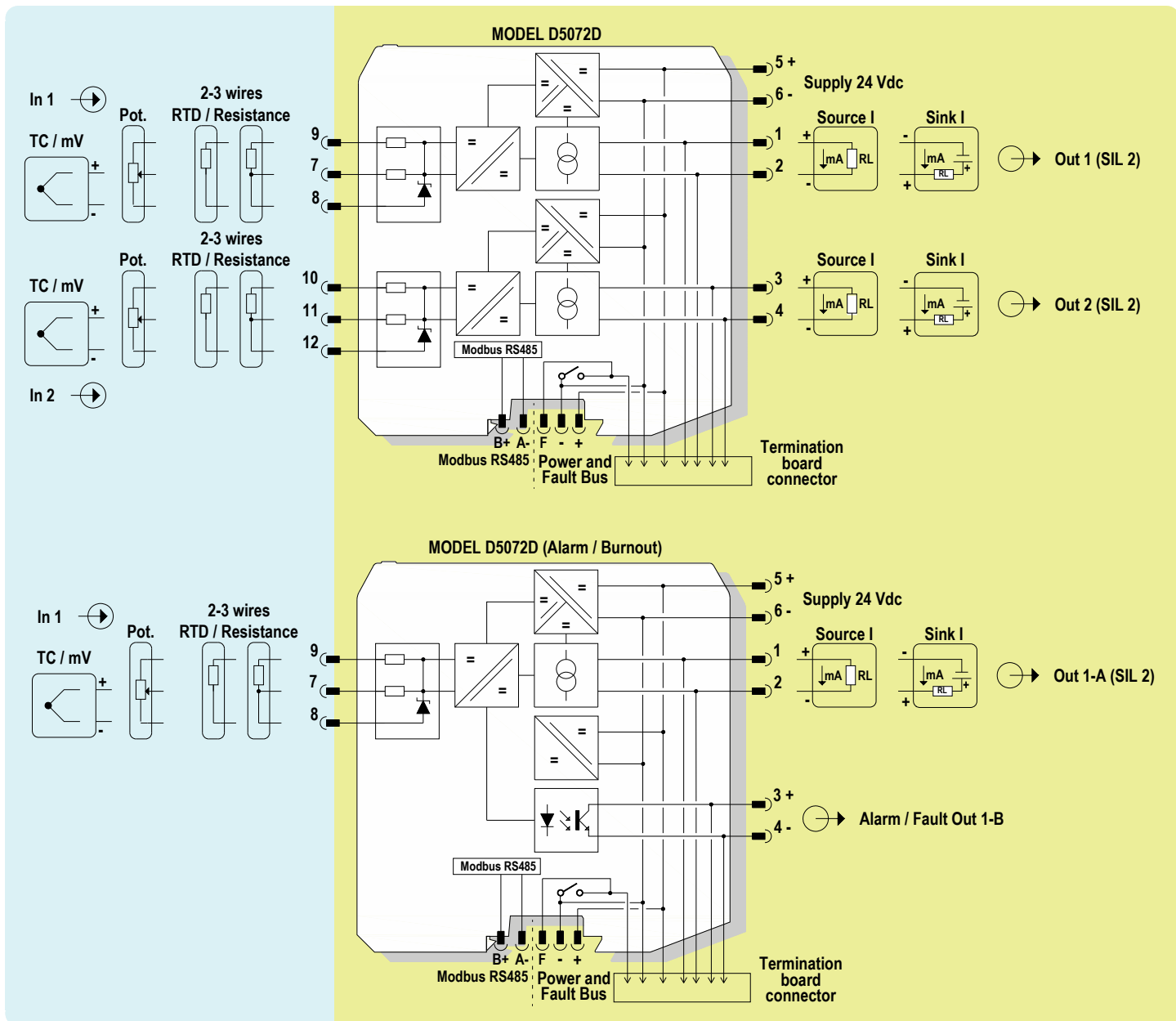

## Function Diagram:

HAZARDOUS AREA ZONE 0 (ZONE 20) GROUP IIC,  
HAZARDOUS LOCATIONS CLASS I, DIVISION 1, GROUPS A, B, C, D,  
CLASS II, DIVISION 1, GROUPS E, F, G, CLASS III, DIVISION 1,  
CLASS I, ZONE 0, GROUP IIC

SAFE AREA, ZONE 2 GROUP IIC T4,  
NON HAZARDOUS LOCATIONS, CLASS I, DIVISION 2,  
GROUPS A, B, C, D T-Code T4, CLASS I, ZONE 2, GROUP IIC T4

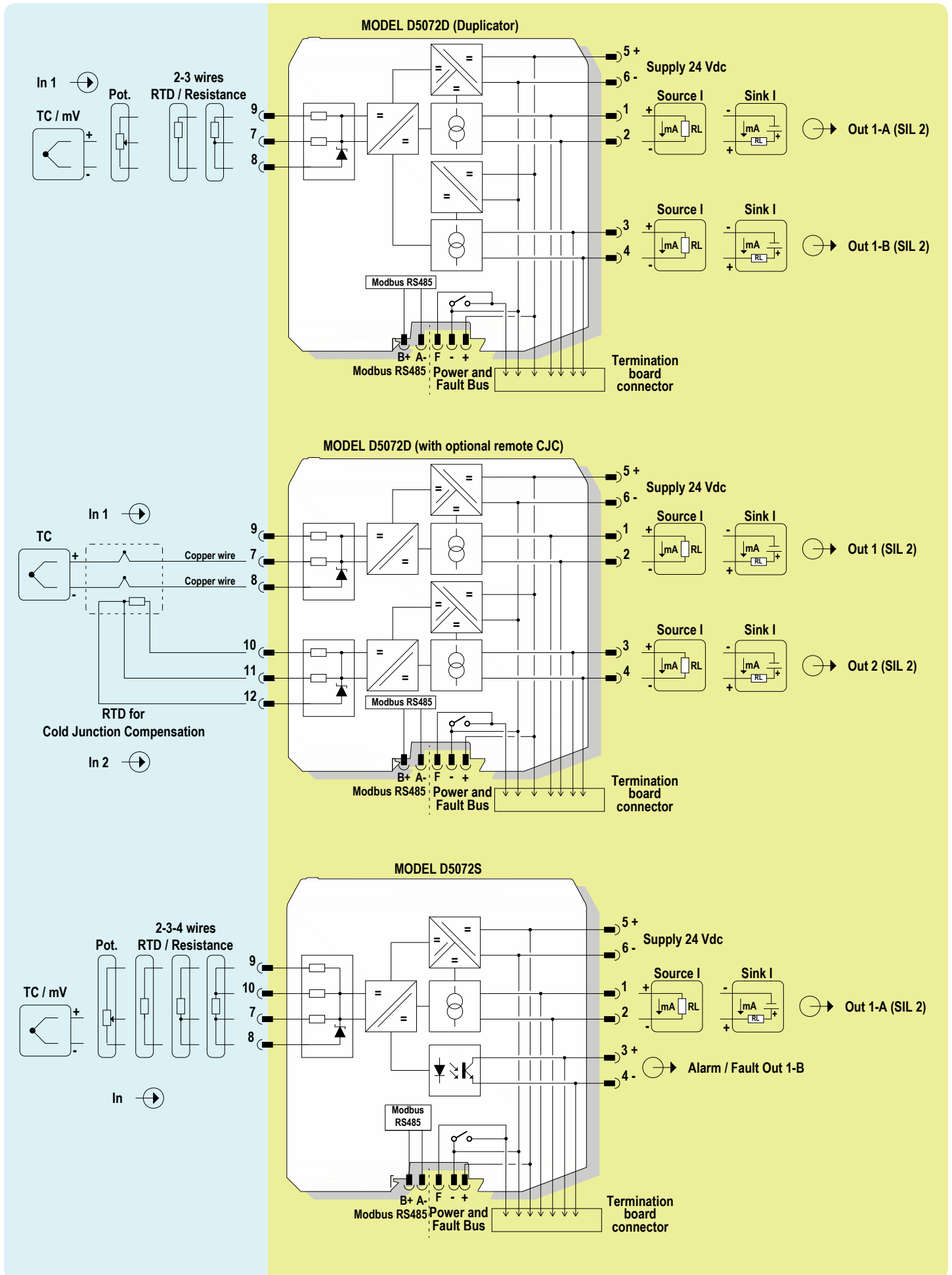

**Input specifications:**

Input	Type	Alpha	Ohms	Standards	Min Span	Accuracy	Accuracy Range	Maximum Range
RTD	Platinum	0.003850	50	IEC 60751	20 °C (36 °F)	±0.4 °C ±0.7 °F	-200 to 850 °C (-328 to 1562 °F)	-200 to 850 °C (-328 to 1562 °F)
			100	IEC 60751	20 °C (36 °F)	±0.2 °C ±0.4 °F	-200 to 850 °C (-328 to 1562 °F)	-200 to 850 °C (-328 to 1562 °F)
			200	IEC 60751		±0.2 °C ±0.4 °F	-200 to 850 °C (-328 to 1562 °F)	-200 to 850 °C (-328 to 1562 °F)
			300	IEC 60751		±0.2 °C ±0.4 °F	-200 to 850 °C (-328 to 1562 °F)	-200 to 850 °C (-328 to 1562 °F)
			400	IEC 60751		±0.2 °C ±0.4 °F	-200 to 850 °C (-328 to 1562 °F)	-200 to 850 °C (-328 to 1562 °F)
			500	IEC 60751		±0.2 °C ±0.4 °F	-200 to 850 °C (-328 to 1562 °F)	-200 to 850 °C (-328 to 1562 °F)
			1000	IEC 60751		±0.2 °C ±0.4 °F	-200 to 850 °C (-328 to 1562 °F)	-200 to 850 °C (-328 to 1562 °F)
		0.003916	100	ANSI		20 °C (36 °F)	±0.2 °C ±0.4 °F	-200 to 625 °C (-328 to 1157 °F)
		0.003910	46	GOST 6651	20 °C (36 °F)	±0.4 °C ±0.7 °F	-200 to 650 °C (-328 to 1202 °F)	-200 to 650 °C (-328 to 1202 °F)
			50	GOST 6651		±0.4 °C ±0.7 °F	-200 to 650 °C (-328 to 1202 °F)	-200 to 650 °C (-328 to 1202 °F)
			100	GOST 6651		±0.2 °C ±0.4 °F	-200 to 650 °C (-328 to 1202 °F)	-200 to 650 °C (-328 to 1202 °F)
			200	GOST 6651		±0.2 °C ±0.4 °F	-200 to 650 °C (-328 to 1202 °F)	-200 to 650 °C (-328 to 1202 °F)
			300	GOST 6651		±0.2 °C ±0.4 °F	-200 to 650 °C (-328 to 1202 °F)	-200 to 650 °C (-328 to 1202 °F)
			400	GOST 6651		±0.2 °C ±0.4 °F	-200 to 650 °C (-328 to 1202 °F)	-200 to 650 °C (-328 to 1202 °F)
	Nickel	0.00618	100	DIN 43760	20 °C (36 °F)	±0.2 °C ±0.4 °F	-60 to 180 °C (-76 to 356 °F)	-60 to 180 °C (-76 to 356 °F)
		0.00672	120	DIN 43760		±0.2 °C ±0.4 °F	-80 to 320 °C (-112 to 608 °F)	-80 to 320 °C (-112 to 608 °F)
	Copper	0.00428	50	GOST 6651	20 °C (36 °F)	±0.4 °C ±0.7 °F	-50 to 200 °C (-58 to 392 °F)	-50 to 200 °C (-58 to 392 °F)
			53	GOST 6651	20 °C (36 °F)	±0.4 °C ±0.7 °F	-50 to 200 °C (-58 to 392 °F)	-50 to 200 °C (-58 to 392 °F)
			100	GOST 6651	20 °C (36 °F)	±0.2 °C ±0.4 °F	-50 to 200 °C (-58 to 392 °F)	-50 to 200 °C (-58 to 392 °F)
		0.00427	9.035	---	20 °C (36 °F)	±1.0 °C ±1.8 °F	-50 to 260 °C (-58 to 500 °F)	-50 to 260 °C (-58 to 500 °F)
	Ohm	Resistance	0 to 4000	---	1 ohm	±0.4 ohm	0 to 4000	0 to 4000
Potentiometer		100 to 10000	---	1 %	±0.1%	0 to 100%	0 to 100%	
TC	A1	---	GOST 8.585-2001	20 °C (36 °F)	±0.75 °C ±1.35 °F	25 to 2500 °C (77 to 4532 °F)	-10 to 2500 °C (14 to 4532 °F)	
	A2	---	GOST 8.585-2001	20 °C (36 °F)	±0.75 °C ±1.35 °F	25 to 1800 °C (77 to 3272 °F)	-10 to 1800 °C (14 to 3272 °F)	
	A3	---	GOST 8.585-2001	20 °C (36 °F)	±0.75 °C ±1.35 °F	25 to 1800 °C (77 to 3272 °F)	-10 to 1800 °C (14 to 3272 °F)	
	B	---	IEC 60584 GOST 8.585-2001	100 °C (180 °F)	±0.75 °C ±1.35 °F	180 to 1800 °C (356 to 3272 °F)	-10 to 1800 °C (14 to 3272 °F)	
	E	---	IEC 60584 GOST 8.585-2001	20 °C (36 °F)	±0.3 °C ±0.6 °F	-100 to 1000 °C (-148 to 1832 °F)	-250 to 1000 °C (-418 to 1832 °F)	
	J	---	IEC 60584 GOST 8.585-2001	20 °C (36 °F)	±0.3 °C ±0.6 °F	-125 to 750 °C (-193 to 1382 °F)	-200 to 1200 °C (-328 to 2192 °F)	
	K	---	IEC 60584 GOST 8.585-2001	20 °C (36 °F)	±0.3 °C ±0.6 °F	-125 to 1350 °C (-193 to 2462 °F)	-250 to 1350 °C (-418 to 2462 °F)	
	L	---	DIN 43710	20 °C (36 °F)	±0.3 °C ±0.6 °F	-100 to 800 °C (-148 to 1472 °F)	-200 to 800 °C (-328 to 1472 °F)	
	LR	---	GOST 8.585-2001	20 °C (36 °F)	±0.3 °C ±0.6 °F	-75 to 800 °C (-103 to 1472 °F)	-200 to 800 °C (-328 to 1472 °F)	
	N	---	IEC 60584 GOST 8.585-2001	20 °C (36 °F)	±0.3 °C ±0.6 °F	-100 to 1300 °C (-148 to 2372 °F)	-250 to 1300 °C (-418 to 2372 °F)	
	R	---	IEC 60584 GOST 8.585-2001	20 °C (36 °F)	±0.5 °C ±0.9 °F	75 to 1750 °C (167 to 3182 °F)	-50 to 1750 °C (-58 to 3182 °F)	
	S	---	IEC 60584 GOST 8.585-2001	20 °C (36 °F)	±0.5 °C ±0.9 °F	75 to 1750 °C (167 to 3182 °F)	-50 to 1750 °C (-58 to 3182 °F)	
	T	---	IEC 60584 GOST 8.585-2001	20 °C (36 °F)	±0.3 °C ±0.6 °F	-100 to 400 °C (-148 to 752 °F)	-250 to 400 °C (-418 to 752 °F)	
	U	---	DIN 43710	20 °C (36 °F)	±0.3 °C ±0.6 °F	-100 to 400 °C (-148 to 752 °F)	-200 to 600 °C (-328 to 1112 °F)	
mV	DC	---	---	1 mV	±10 µV	-50 to 80 mV	-50 to 80 mV	

**Notes:**

RTD/resistance accuracy shown in 4-wires configuration, in slow acquisition mode

TC/mV Accuracy shown in slow acquisition mode

## Configuration parameters:

### INPUT:

#### Sensor Connection:

- TC
- RTD
- Potentiometer
- Voltage
- Resistance

**Sensor Type:** input sensor type (see list in section "Input specifications")

possibility of configuring a completely customized TC/RTD input curve

**Wires:** 2, 3, 4 wires selection for RTD/Resistance inputs

**Cold Junction Source:** reference junction compensation type (thermocouple only)

- Automatic via internal compensator (1 for each channel)
- Fixed programmable temperature compensation at fixed temperature
- Other Input remote compensation using RTD on remaining channel

**Cold Junction Reference:** fixed temperature compensation value (Cold Junction type Fixed only), range from -60 to +100 °C.

#### Integration speed:

- Slow 250 ms (mV/TC, 2 wire RTD); 375 ms (Pot.), 500 ms (3,4 wire RTD)
- Fast 50 ms (mV/TC, 2 wire RTD); 75 ms (Pot.), 100 ms (3,4 wire RTD)

#### Mains Frequency:

- 50 Hz
- 60 Hz only available with fast integration speed

**Offset:** value to be added/subtracted to input (µV or mΩ depending on input sensor);

**Multiplier:** input multiplication value;

**Tag:** 16 alphanumeric characters

### OUTPUT:

#### Function:

- Input 1 analog output represents input of first channel,
- Input 2 analog output represents input of second channel,
- Input 1 + 2 analog output represents the sum of the two input channels,
- Input 1 - 2 analog output represents the subtraction of the two input ch.,
- Min(Input 1, Input 2) analog output represents the lower of the two input ch.,
- Max(Input 1, Input 2) analog output represents the higher of the two input ch.

#### Type:

- 0-20 mA Sink
- 4-20 mA Sink (for SIL applications)
- Custom Sink All output parameters are fully customizable.
- 0-20 mA Source
- 4-20 mA Source (for SIL applications)
- Custom Source All output parameters are fully customizable.

**Lowscale:** analog output lowscale in normal working condition (range 0 to 24 mA)

**Highscale:** analog output highscale in normal working condition (range 0 to 24 mA)

**Underrange:** analog output lowscale in underrange condition (range 0 to 24 mA)

**Overrange:** analog output highscale in overrange condition (range 0 to 24 mA)

**Fault Output Value:** analog output value in case of fault condition (range 0 to 24 mA)

**Fault in case of:** analog output is forced to "Fault Output Value" in case of:

- Burnout input sensor interruption,
- Internal fault module internal fault,
- Sensor out of range input sensor out of configured input range,
- Output Saturation output is below Underrange or above Overrange,
- Module Temp. Out of range internal module temperature under or over specified module operating temperature limits.

### ALARM:

#### Type:

- None alarm is disabled,
- Low alarm is triggered when source descends below "Low Set",
- LowLock alarm is inhibited until source ascends over "Low Set", and then, it behaves as a standard "Low" configuration,
- High alarm is triggered when source ascends over "High Set",
- HighLock alarm is inhibited until source descends below "High Set", and then, it behaves as a standard "High" configuration,
- Window alarm is triggered below "Low Set" and above "High Set",
- Fault Repeater alarm output reflects selected (one or more) Fault status.

**Source:** reference value for alarm triggering

- Input 1 input of first channel,
- Input 2 input of second channel,
- Input 1 + 2 sum of the two input channels,
- Input 1 - 2 subtraction of the two input channels,
- Min(Input 1, Input 2) lower of the two input channels,
- Max(Input 1, Input 2) higher of the two input channels.

#### Condition:

- NE alarm output is normally energized when deactivated,
- ND alarm output is normally de-energized when deactivated.

**Low Set:** source value at which the alarm is triggered (in Low, LowLock, Window)

**Low Hysteresys:** triggered Low alarm deactivates when source value reaches Low Set + Low Hysteresys (0-500 °C, 0-50 mV, 0-50 %, 0 to 2 KΩ)

**High Set:** source value at which the alarm is triggered (in High, HighLock, Window)

**High Hysteresys:** triggered High alarm deactivates when source value reaches High Set - High Hysteresys (0-500 °C, 0-50 mV, 0-50 %, 0 to 2 KΩ)

**On Delay:** time for which the source variable has to be in alarm condition before the alarm output is triggered; configurable from 0 to 1000 seconds in steps of 100 ms

**Off Delay:** time for which the source variable has to be in normal condition before the alarm output is deactivated; configurable from 0 to 1000 seconds in steps of 100 ms

#### In case of fault:

- Ignore alarm is not affected
- Lock status alarm remains in the same status as it was before Fault occurred
- Go On alarm is triggered,
- Go Off alarm is deactivated

**Faults:** if "Type" is set to "Fault repeater" select which faults will be repeated by alarm output; if "In case of fault" is different from "Ignore", select which faults should influence alarm output behaviour.

**Note:** Each channel has completely independent configurations  
See ISM0154 Manual for details on SWC5090 software.

## Screenshots:

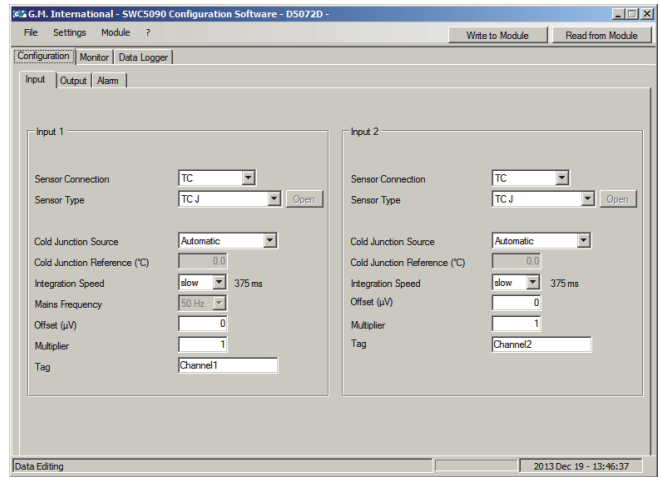

Input configuration

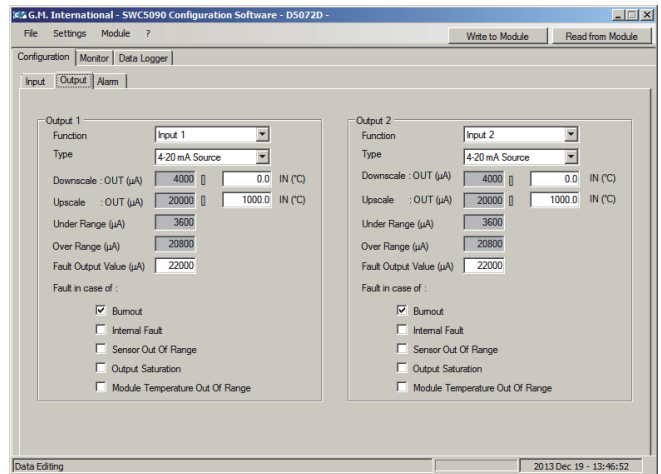

Output configuration

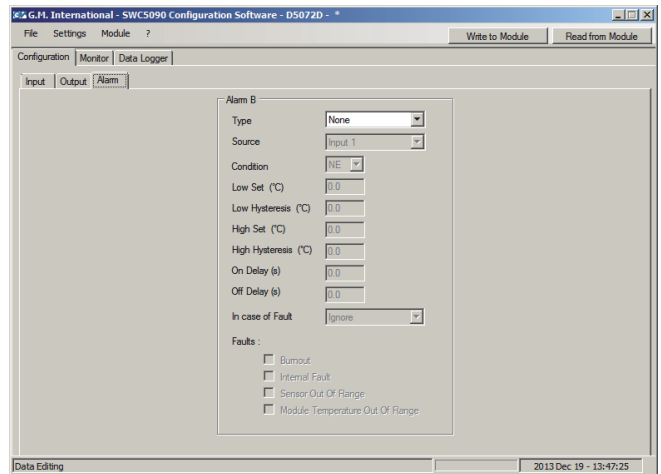

Alarm configuration

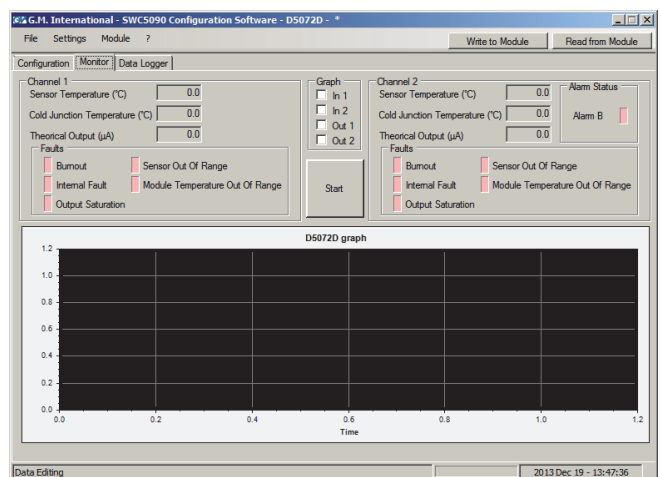

Monitor